

# BD235

Rev.E Mar.-2016

## 描述 / Descriptions

TO-126F 塑封封装 NPN 半导体三极管。 Silicon NPN transistor in a TO-126F Plastic Package.

## 特征 / Features

与 BD236 互补。

Complementary pair with BD236.

## 用途 / Applications

用于中功率电路及开关电路。

Medium power linear and switching applications.

## 内部等效电路 / Equivalent Circuit

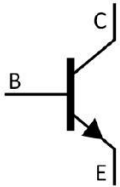

## 引脚排列 / Pinning



PIN1 : Emitter

PIN 2 : Collector

PIN 3 : Base

## 放大及印章代码 / $h_{FE}$ Classifications & Marking

见印章说明。 See Marking Instructions

**极限参数 / Absolute Maximum Ratings(Ta=25°C)**

| 参数<br>Parameter                       | 符号<br>Symbol                | 数值<br>Rating | 单位<br>Unit |
|---------------------------------------|-----------------------------|--------------|------------|
| Collector to Base Voltage             | $V_{CBO}$                   | 60           | V          |
| Collector to Emitter Voltage          | $V_{CEO}$                   | 60           | V          |
| Emitter to Base Voltage               | $V_{EBO}$                   | 5.0          | V          |
| Collector Current - Continuous        | $I_C$                       | 2.0          | A          |
| Collector Current – Continuous(Pulse) | $I_{CP}$                    | 6.0          | A          |
| Collector Power Dissipation           | $P_C$                       | 1.0          | W          |
| Collector Power Dissipation           | $P_C(T_c=25^\circ\text{C})$ | 25           | W          |
| Junction Temperature                  | $T_j$                       | 150          | °C         |
| Storage Temperature Range             | $T_{stg}$                   | -55~150      | °C         |

**电性能参数 / Electrical Characteristics(Ta=25°C)**

| 参数<br>Parameter                         | 符号<br>Symbol  | 测试条件<br>Test Conditions                 | 最小值<br>Min | 典型值<br>Typ | 最大值<br>Max | 单位<br>Unit    |
|---|---------------|---|------------|------------|------------|---------------|
| Collector to Emitter Breakdown Voltage  | $V_{CEO}$     | $I_C=100\text{mA}$ $I_B=0$              | 60         |            |            | V             |
| Collector Cut-Off Current               | $I_{CBO}$     | $V_{CB}=60\text{V}$ $I_E=0$             |            |            | 100        | $\mu\text{A}$ |
| Emitter Cut-Off Current                 | $I_{EBO}$     | $V_{EB}=5.0\text{V}$ $I_C=0$            |            |            | 1.0        | mA            |
| DC Current Gain                         | $h_{FE(1)}$   | $V_{CE}=2.0\text{V}$ $I_C=150\text{mA}$ | 40         |            | 400        |               |
|   | $h_{FE(2)}$   | $V_{CE}=2.0\text{V}$ $I_C=1.0\text{A}$  | 25         |            |            |               |
| Collector to Emitter Saturation Voltage | $V_{CE(sat)}$ | $I_C=1.0\text{A}$ $I_B=0.1\text{A}$     |            |            | 0.6        | V             |
| Base to Emitter Voltage                 | $V_{BE}$      | $V_{CE}=2.0\text{V}$ $I_C=1.0\text{A}$  |            |            | 1.3        | V             |
| Transition Frequency                    | $f_T$         | $V_{CE}=10\text{V}$ $I_C=250\text{mA}$  | 3.0        |            |            | MHz           |

电参数曲线图 / Electrical Characteristic Curve

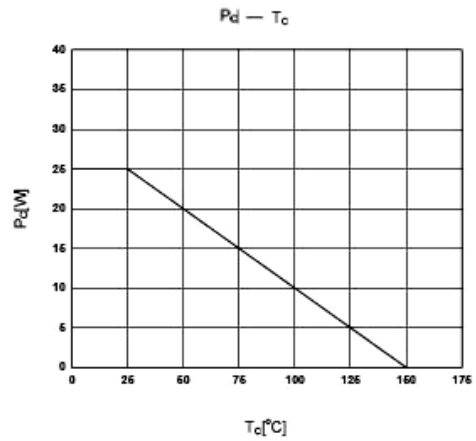
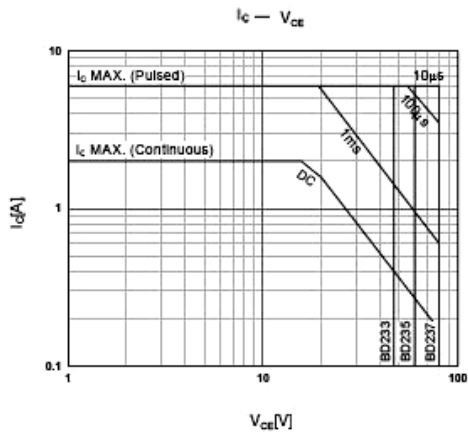
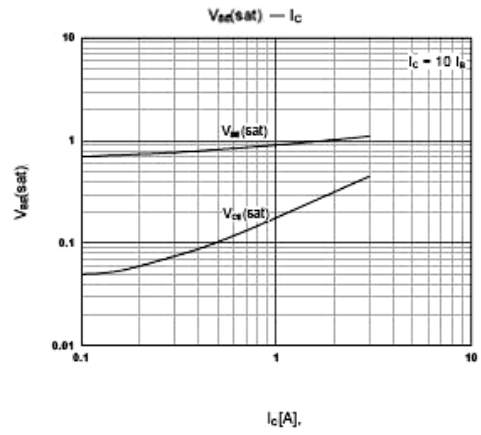
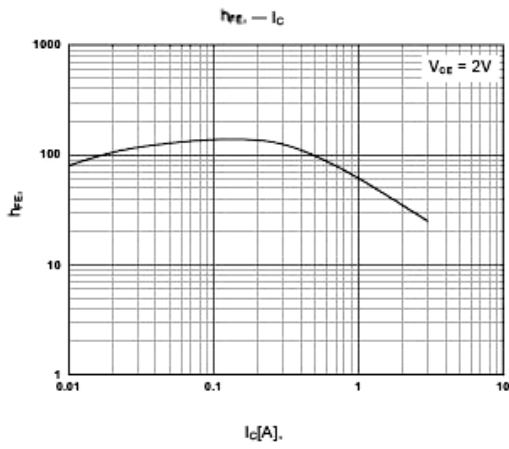

外形尺寸图 / Package Dimensions

T0-126F

单位: mm

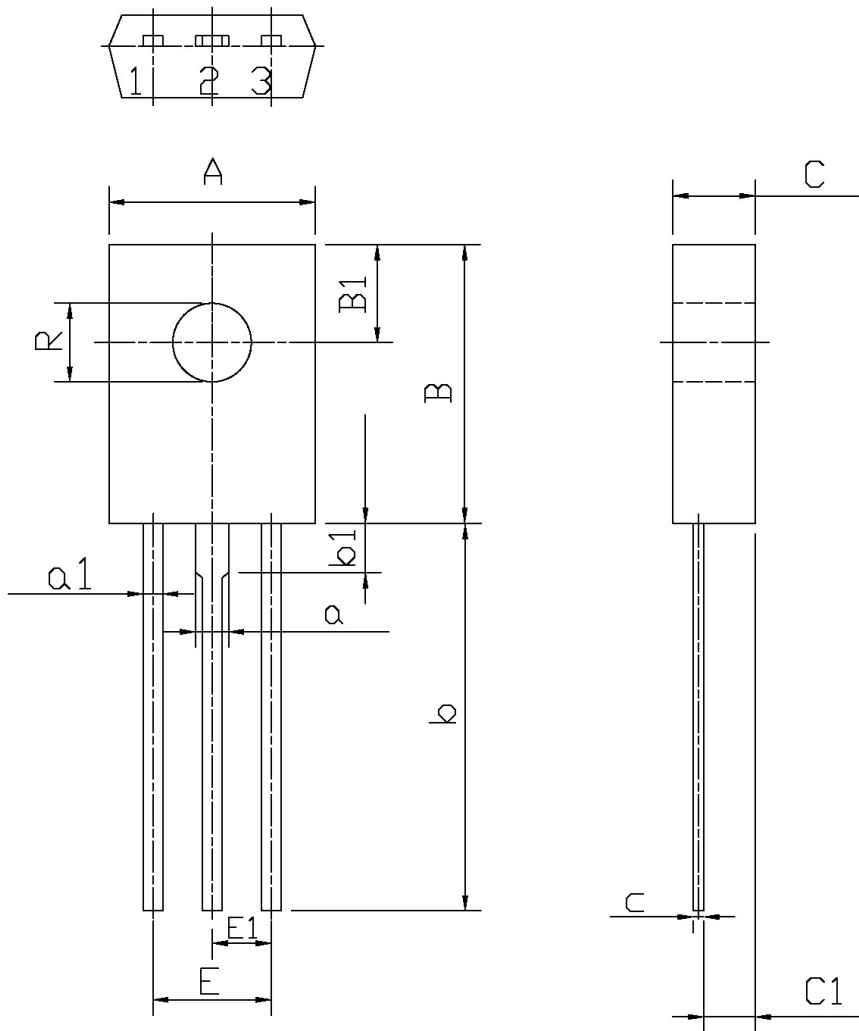

| Symbol | Dimensions In Millimeters |      | Symbol | Dimensions In Millimeters |      |
|--------|---------------------------|------|--------|---------------------------|------|
|        | Min                       | Max  |        | Min                       | Max  |
| A      | 7.8                       | 8.2  | a1     | 0.66                      | 0.86 |
| B      | 10.8                      | 11.2 | E      | 4.4                       | 4.8  |
| B1     | 3.8                       | 4.2  | C      | 3.1                       | 3.3  |
| R      | 2.95                      | 3.15 | C1     | 1.9                       | 2.1  |
| b      | 14                        | 16   | c      | 0.3                       | 0.6  |
| b1     | 1.9                       |      | a      | 1.27                      |      |
| E1     | 2.1                       | 2.5  |        |                           |      |

印章说明 / Marking Instructions

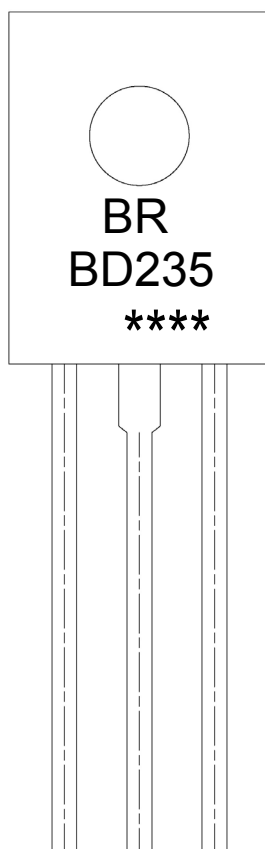

说明：

BR： 为公司代码

BD235： 为产品型号

\*\*\*\*： 为生产批号代码，随生产批号变化。

Note:

BR: Company Code

BD235: Product Type.

\*\*\*\*: Lot No. Code, code change with Lot No.

**波峰焊温度曲线图(无铅) / Temperature Profile for Dip Soldering(Pb-Free)**



说明：

- 1、预热温度 25 ~ 150°C，时间 60 ~ 90sec;
- 2、峰值温度 255±5°C，时间持续为 5±0.5sec;
- 3、焊接制程冷却速度为 2 ~ 10°C/sec.

Note:

- 1.Preheating:25~150°C, Time:60~90sec.
- 2.Peak Temp.:255±5°C, Duration:5±0.5sec.
3. Cooling Speed: 2~10°C/sec.

**耐焊接热试验条件 / Resistance to Soldering Heat Test Conditions**

温度：270±5°C

时间：10±1 sec.

Temp.:270±5°C

Time:10±1 sec

**包装规格 / Packaging SPEC.**

散件包装 / BULK

| Package Type<br>封装形式 | Units 包装数量         |                         |                        |                              |                        | Dimension 包装尺寸 (unit: mm <sup>3</sup> ) |             |             |
|----------------------|--------------------|-------------------------|------------------------|------------------------------|------------------------|---|-------------|-------------|
|                      | Units/Tube<br>只/套管 | Tubes/Inner Box<br>套管/盒 | Units/Inner Box<br>只/盒 | Inner Boxes/Outer Box<br>盒/箱 | Units/Outer Box<br>只/箱 | Tube 套管                                 | Inner Box 盒 | Outer Box 箱 |
| TO-126/F             | 500                | 6                       | 3,000                  | 5                            | 15,000                 | 135×190                                 | 237×172×102 | 560×245×195 |

套管包装 / TUBE

| Package Type<br>封装形式 | Units 包装数量         |                         |                        |                              |                        | Dimension 包装尺寸 (unit: mm <sup>3</sup> ) |             |             |
|----------------------|--------------------|-------------------------|------------------------|------------------------------|------------------------|---|-------------|-------------|
|                      | Units/Tube<br>只/套管 | Tubes/Inner Box<br>套管/盒 | Units/Inner Box<br>只/盒 | Inner Boxes/Outer Box<br>盒/箱 | Units/Outer Box<br>只/箱 | Tube 套管                                 | Inner Box 盒 | Outer Box 箱 |
| TO-126/F             | 65                 | 26                      | 1,690                  | 5                            | 8,450                  | 532×31×5.6                              | 555×164×50  | 575×290×180 |

**使用说明 / Notices**